

SERIES JL - K

Replacement Castors for JLB 3 K to JL 12 K

Pos	Name	Dimensions- [mm]	Order -No.
1a	Polyamide Castor incl. 2 x bearing	85 x 85 x 25	95 050 023 - P
1b	JUWATHan-Plus® Castor incl. 2 x bearing	85 x 85 x 25	95 050 057 - V
13	Supporting wheel	Ø 75	95 050 014 - P

Pos	Name	JLB 3 K		JLB 6 K		JL 9 K		JL 12 K	
		Dimensions [mm]	Order-No.	Dimensions [mm]	Order-No.	Dimensions [mm]	Order-No.	Dimensions [mm]	Order-No.
6 9	Axle with circlips	25 x 278	Ac 08 026	25 x 200	Ac 08 027	25 x 300	Ac 08 003	25 x 385	Ac 08 004
4	Rubber pad for turntable	Ø150	No 05 070	Ø150	No 05 070	Ø170	No 05 011	Ø170	No 05 011
2 3	Turntable incl. thrust bearing	Ø 150	L 3 44 000	Ø 150	L 3 24 000	Ø 170	L 9 04 000	Ø 170	L 9 04 000
10 11 10 11 12	Pole	Length 990 He 3 03 000		Length 1120 He 01 022		Length 1120 He 01 022		Length 1120 He 01 022	

STEERABLE TRANSPORT CASTOR TROLLEYS

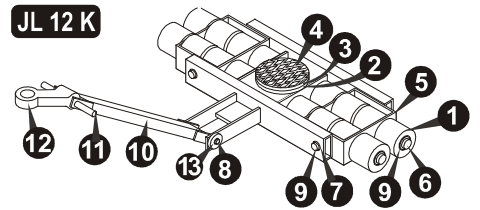
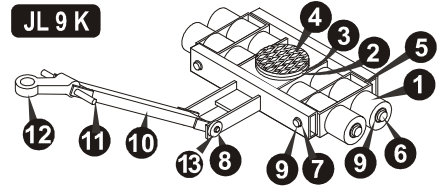
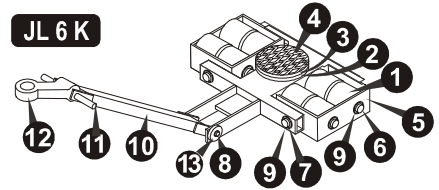
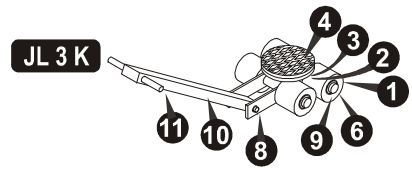

SERIES JFB - K

Replacement Castors for JFB 3 K to JF 12 K

Pos	Name	Dimensions [mm]	Order -No.
1a	Polyamide Castor incl. 2 x bearing	85 x 85 x 25	95 050 023 - P
1b	JUWATHan-plus® Castor incl. 2 x bearing	85 x 85 x 25	95 050 057 - V

Pos	Name	JFB 3 K		JFB 6 K		JF 9 K		JF 12 K	
		Dimensions	Order-No.	Dimensions	Order-No.	Dimensions	Order-No.	Dimensions	Order-No.
2 8	Axle with circlips	25 x 112	Ac 08 023	25 x 207	Ac 08 025	25 x 300	Ac 08 003	25 x 390	Ac 08 004
3	Rubber pad	120x80	F 4 02 008	180 x 170	F 9 05 010	180 x 170	F 9 05 010	200 x 220	F 12 05 010
4 5 6 7	Connection rod	Length 1000 F 1 03 000		Length 1030 F 6 04 010		Length 1230 He 01 038		Length 1230 He 01 038	

ADJUSTABLE TRANSPORT CASTOR TROLLEYS

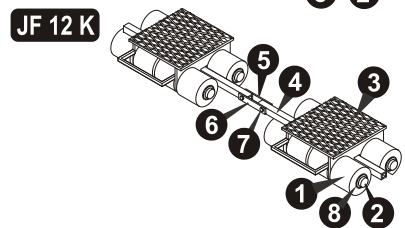
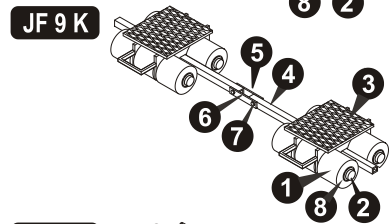
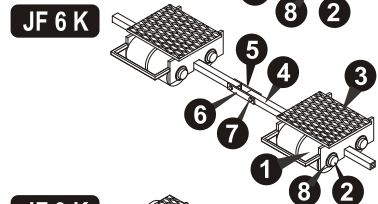
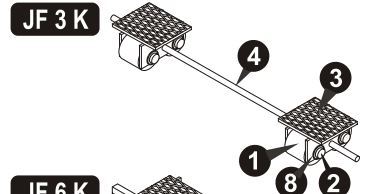

SERIES JL - S

Replacement Castors for JL 12 S to JL 18 S

Pos	Name	Dimension [mm]	Order - No.
1a	Polyamide Castor incl. 2 x bearing	90 x 120 x35	95 050 026-S
1b	JUWAthan® Castor incl. 2 x bearing	90 x 120 x35	95 050 025-V

Pos	Name	JL 12 S		JL 18 S		JL 24 S	
		Dimensions [mm]	Order -No.	Dimensions [mm]	Order -No.	Dimensions [mm]	Order -No.
6 9	Axle with circlips	35 x 310	Ac 08 009	35 x 415	Ac 08 010	35 x 295	Ac 08 024
4	Rubber pad for turntable	Ø 170	No 05 011	Ø 215	L 18 14 001	Ø 215	L 18 14 001
3 4	Turntable incl. Rubber pad	Ø 170	L 9 04 001	Ø 215	L 9 04 000	Ø 215	L 18 14 002
2	Thrust bearing	Ø 170	No 05 015	Ø 215	No 05 029	Ø 215	No 05 029
10 12	Pole	1230 Length He 01 047		1230 Length He 01 047		1230 Length L 40 06 000	

STEERABLE TRANSPORT CASTOR TROLLEYS

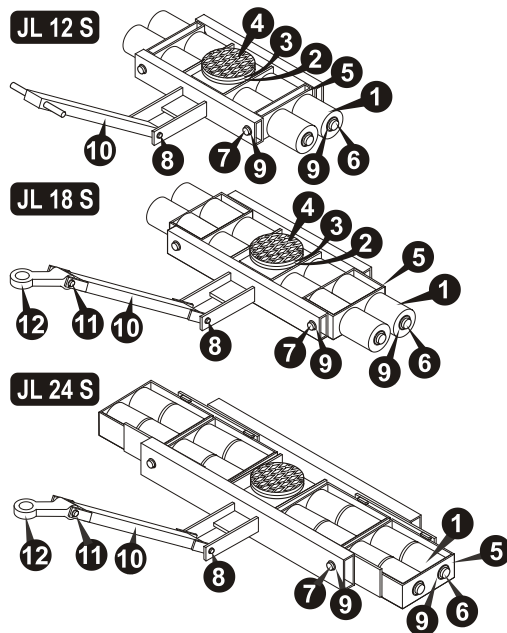

SERIES JF - S

Replacement Castors for JF 12 S to JF 24 S

Pos	Name	Dimensions [mm]	Order - No.
1a	Steel castor incl. 2x bearing	90 x 120 x35	95 050 026 - S
1b	JUWAthan® Castor incl. 2 x bearing	90 x 120 x35	95 050 025 - V

Pos	Name	JF 12 S		JF 18 S		JF 24 S	
		Dimensions [mm]	Order -No.	Dimensions [mm]	Order -No.	Dimensions [mm]	Order -No.
2 5	Axle with circlips	35 x 405	Ac 08 015	35 x 405	Ac 08 015	35 x 295	Ac 08 017
3	Rubber pad for turntable	200 x 220	F 12 05 010	200 x 220	F 12 05 010	260 x 260	F 24 15 001
4 5 6 7	Connection rod	1230 Length He 01 038		1230 Length He 01 038		1230 Length He 01 038	

ADJUSTABLE TRANSPORT CASTOR TROLLEYS

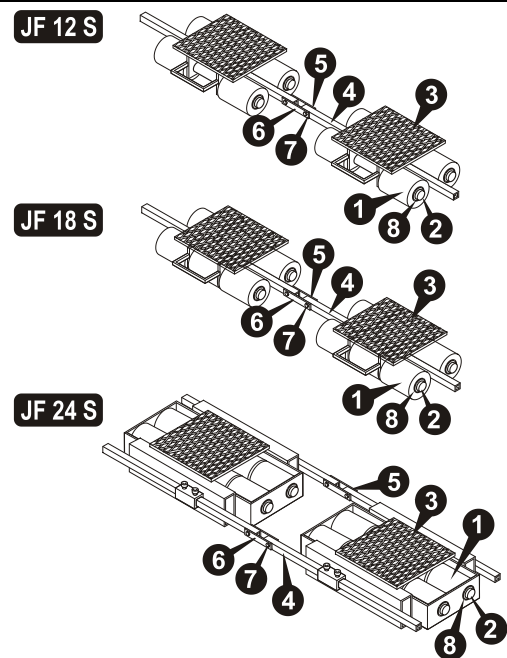

SERIES JL - G

Replacement Castors for JL 15 G to JL 40 G

Pos	Name	Dimensions [mm]	Order - No.
1	JUWAtan® Castor incl. 2 x bearing	140 x 120 x 35	95 050 028-V

Pos	Name	JL 15 G		JL 22 G		JL 30 G		JL 40 G	
		Dimensions [mm]	Order-No	Dimensions [mm]	Order-No	Dimensions [mm]	Order-No	Dimensions [mm]	Order-No
6 9	Axle with circlips	35 x 285 Ac 08 022		35 x 405 Ac 08 014		35 x 290 Ac 08 017		35 x 415 Ac 08 010	
4	Rubber pad for turntable	Ø 215 L 18 14 001		Ø 250 No 05 017		Ø 250 No 05 017		Ø 250 No 05 017	
3 4	Turntable incl. Rubber pad	Ø 215 L 15 04 001		Ø 250 HL 25 05 001		Ø 250 HL 25 05 001		Ø 250 L 40 05 001	
2	Thrust bearing	Ø 170 No 05 015		Ø 250 No 05 016		Ø 250 No 05 016		Ø 250 No 05 016	
10 11 12	Pole	1230 Length He 01 047		1580 Length HL 25 06 042		1590 Length L 40 06 000		1590 Length L 40 06 000	

STEERABLE TRANSPORT CASTOR TROLLEYS

JL 15 G

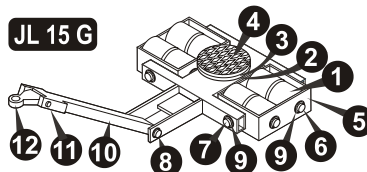

JL 22 G

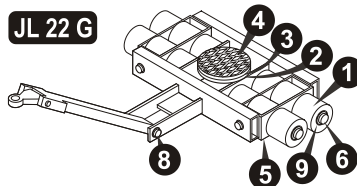

JL 30 G

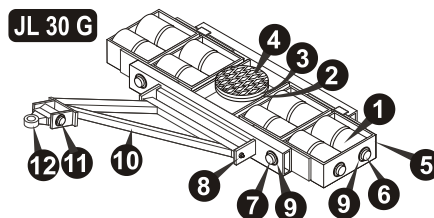

JL 40 G

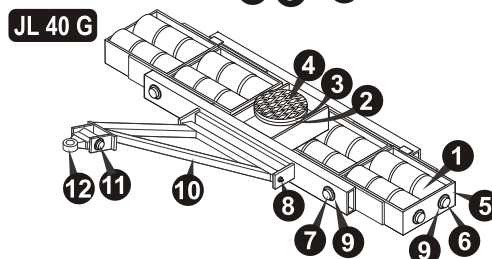

SERIES JF - G

Replacement Castors for JF 15 G to JF 40 G

Pos	Name	Dimensions [mm]	Order - No.
1	JUWAtan® Castor incl. 2 x bearing	140 x 120 x 35	95 050 028-V

Pos	Name	JF 15 G		JF 22 G		JF 30 G		JF 40 G	
		Dimensions [mm]	Order-No.	Dimensions [mm]	Order-No	Dimensions [mm]	Order-No	Dimensions [mm]	Order-No
2 5	Axle with circlips	35 x 285 Ac 08 022		35 x 405 Ac 08 015		35 x 290 Ac 08 017		35 x 415 Ac 08 010	
3	Rubber pad	260 x 315 No 05 042		260 x 315 No 05 042		260 x 440 F 3005 010		300 x 440 F 40 05 010	
4	Connection rod	1540 Length Fs 09 046		1540 Length Fs 09 046		1540 Length Fs 09 046		1540 Length Fs 09 046	

ADJUSTABLE TRANSPORT CASTOR TROLLEYS

JF 15 G

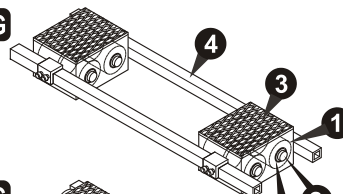

JF 22 G

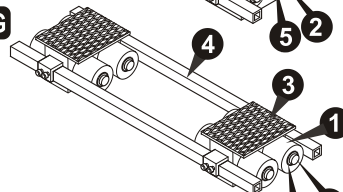

JF 30 G

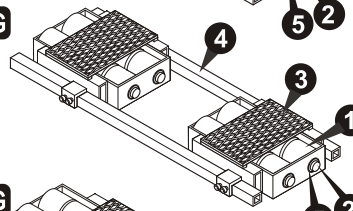

JF 40 G

